





SINGLE MAST EASEL

assembly instructions

HARDWARE

-  A (x2)
-  B
-  C (x3)
-  D (x2)
-  E (x3)

Screwdriver required for Step 3

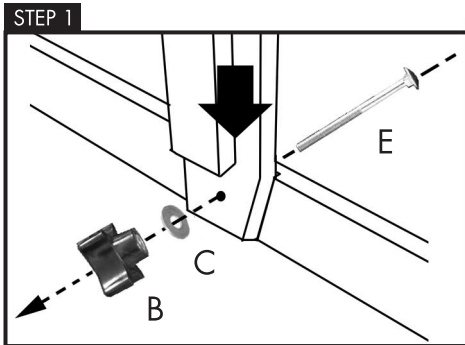

Attach center mast to base.

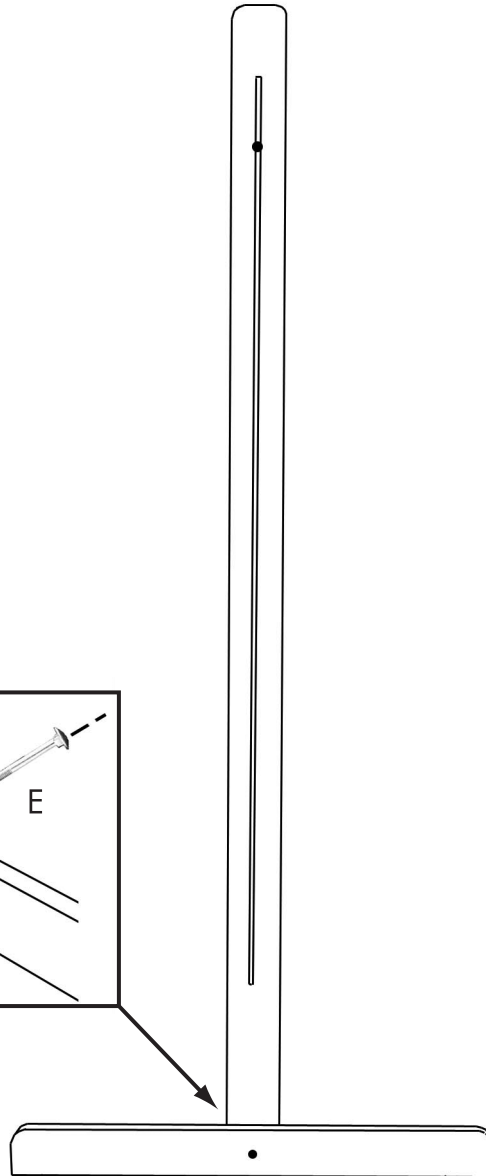

STEP 2

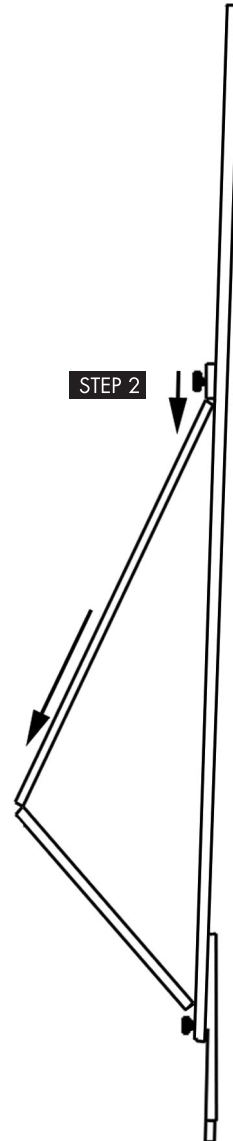

Loosen top knob on the back side of the center mast and extend rear support leg until the hinged joint meets the floor. Tighten the knob to lock the support in place.

STEP 4

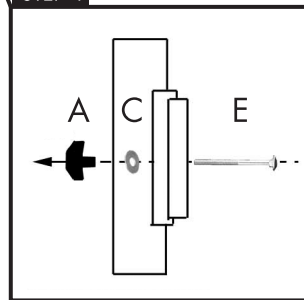

Attach upper and lower canvas trays.

STEP 3

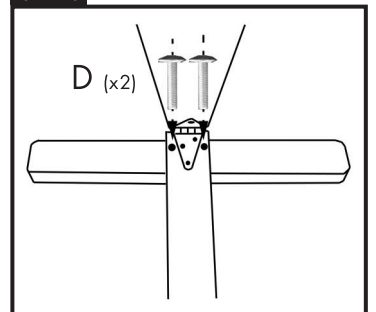

Attach rear support leg to base.

